



# **Data Loss Prevention MTA Integration Guide for Network Prevent for Email**

**Version 15.7**

---

# Table of Contents

<b>Introduction.....</b>	<b>4</b>
<b>About the Network Prevent for Email Server.....</b>	<b>4</b>
Operating modes for Network Prevent for Email Server.....	4
About hosted Network Prevent deployments.....	4
<b>Environment compatibility and requirements for Network Prevent for Email.....</b>	<b>5</b>
<b>About selecting an integration architecture.....</b>	<b>5</b>
<b>Network Prevent for Email Server Response Rules.....</b>	<b>6</b>
<b>About Network Prevent for Email response rules.....</b>	<b>6</b>
<b>About message blocking.....</b>	<b>6</b>
<b>About messages redirecting.....</b>	<b>6</b>
<b>About downstream message tagging.....</b>	<b>7</b>
<b>MTA Integration Architecture.....</b>	<b>8</b>
<b>About integration architectures.....</b>	<b>8</b>
<b>About the Network Prevent for Email Server message chain.....</b>	<b>8</b>
<b>Integration architectures for reflecting mode.....</b>	<b>10</b>
About second SMTP listener-based routing.....	10
About SMTP client IP address-based routing.....	11
About HELO identification string-based routing.....	12
About message header-based routing.....	13
<b>About the integration architecture for forwarding mode.....</b>	<b>13</b>
About next-hop MTA selection.....	14
<b>About TLS authentication.....</b>	<b>15</b>
<b>Configuring keys and certificates for TLS.....</b>	<b>15</b>
<b>Changing the Network Prevent for Email Server keystore password.....</b>	<b>17</b>
<b>Generating Network Prevent for Email Server keys.....</b>	<b>18</b>
<b>Exporting the Network Prevent for Email Server public key certificate.....</b>	<b>19</b>
<b>Importing public key certificates to the Network Prevent for Email Server keystore.....</b>	<b>19</b>
<b>Configuring Network Prevent for Email Server for reflecting or forwarding mode.....</b>	<b>21</b>
Configuring Linux IP tables to reroute traffic from a restricted port.....	23
<b>Capacity and Fault Tolerance.....</b>	<b>24</b>
<b>About capacity and fault tolerance.....</b>	<b>24</b>
<b>About capacity management and fault tolerance implementation.....</b>	<b>24</b>
<b>About capacity management.....</b>	<b>24</b>
About MX-Based clusters.....	24
About IP load balancer-based clusters.....	25
Example of bi-directional load balancing.....	25

---

Example of uni-directional load balancing.....	26
<b>About fault tolerance planning.....</b>	<b>27</b>
About MX-based bypass.....	27
About MTA-based queue management.....	28
<b>Integration Testing.....</b>	<b>29</b>
<b>About Network Prevent for Email Server integration testing.....</b>	<b>29</b>
<b>About functional tests.....</b>	<b>29</b>
<b>About basic failover tests.....</b>	<b>29</b>
<b>Appendix A: Email Message Systems.....</b>	<b>31</b>
<b>About store and forward email systems.....</b>	<b>31</b>
<b>About the DNS system.....</b>	<b>31</b>
<b>Appendix B: MTA Integration Checklist.....</b>	<b>32</b>
<b>About the MTA integration checklist.....</b>	<b>32</b>
<b>Completing the Network Prevent for Email Server integration prerequisites.....</b>	<b>32</b>
<b>Selecting an integration architecture.....</b>	<b>33</b>
<b>Evaluating message stream component capacity.....</b>	<b>33</b>
<b>Integrating Network Prevent for Email with MTAs.....</b>	<b>33</b>

---

# Introduction

---

## About the Network Prevent for Email Server

Network Prevent for Email Server is a detection server that analyzes email messages and blocks or modifies them as required by your policies. It can receive email messages from one or more mail transfer agents (MTAs) in your network.

The Network Prevent for Email Server supports SMTP error response relay, the SMTP command verb `EHLO`, and the following extensions to SMTP:

- 8BITMIME
- VRFY
- DSN
- HELP
- PIPELINING
- SIZE
- ENHANCEDSTATUSCODES
- STARTTLS

The Network Prevent for Email Server does not store messages locally, and it is therefore not an MTA. The Network Prevent for Email Server is never the only message handler holding the message. It maintains each inbound SMTP message transaction only until the outbound transaction has been closed.

Network Prevent for Email Server can receive TLS-encrypted email from an upstream MTA. It can also initiate a TLS session to an outbound MTA, a hosted email service, or the reflecting-mode MTA as necessary.

[About integration architectures](#)

[About TLS authentication](#)

### NOTE

You must implement the Network Prevent for Email Server only into your outbound SMTP message stream.

## Operating modes for Network Prevent for Email Server

You can configure the Network Prevent for Email Server to operate in one of the following modes:

- Reflecting mode  
In reflecting mode, the Network Prevent for Email Server receives messages from an MTA, analyzes them, and then reflects them back to the same MTA.
- Forwarding Mode  
In forwarding mode, the Network Prevent for Email Server receives messages from an upstream MTA, analyzes them, and sends them on to a downstream MTA. It can also send them to a hosted email service such as Email Security.cloud.

[Configuring Network Prevent for Email Server for reflecting or forwarding mode](#)

## About hosted Network Prevent deployments

Symantec Data Loss Prevention supports deploying one or more Network Prevent detection servers in a hosted service provider network, or in a network location that requires communication across a Wide Area Network (WAN). You may want to deploy a Network Prevent server in a hosted environment if you use a service provider's mail server or Web proxy.

---

In this way, the Network Prevent server can be easily integrated with the remote proxy to prevent confidential data loss through email or HTTP posts.

You can deploy the Enforce Server and detection servers to the Amazon Web Services infrastructure. For additional related information see the *Symantec Data Loss Prevention Deployment Guide for Amazon Web Services*, available in the [Related Documents](#) section of the Symantec Data Loss Prevention Help Center.

When you choose to install a detection server, the Symantec Data Loss Prevention installation program asks if you want to install Network Prevent in a hosted environment.

If you choose to install a Network Prevent detection server in a hosted environment, you must use the `sslkeytool` utility to create multiple, user-generated certificates to use with both internal (corporate) and hosted detection servers. This ensures secure communication from the Enforce Server to the hosted Network Prevent server, and to all other detection servers that you install. You cannot use the built-in Symantec Data Loss Prevention certificate when you deploy a hosted Network Prevent detection server.

The *Symantec Data Loss Prevention Installation Guide*, available in the [Related Documents](#) section of the Symantec Data Loss Prevention Help Center, describes how to install and configure the Network Prevent server in either a hosted or non-hosted (WAN) environment.

## Environment compatibility and requirements for Network Prevent for Email

The Network Prevent for Email Server is compatible with a wide range of enterprise-grade third-party SMTP-compliant MTAs and hosted email services. Consult your MTA vendor or hosted email service for specific support questions.

**Network Prevent for Email Server can integrate with an MTA or hosted email service that meets the following requirements:**

- The MTA or hosted email service must be capable of strict SMTP compliance. It must be able to send and receive mail using only the following command verbs: HELO (or EHLO), RCPT TO, MAIL FROM, QUIT, NOOP, and DATA.
- When running the Network Prevent for Email Server in reflecting mode, the upstream MTA must be able to route messages to the Network Prevent for Email Server only once for each message.

You can use an SMTP-compliant MTA that routes outbound messages from your internal mail infrastructure to the Network Prevent for Email Server. For reflecting mode compatibility, the MTA must also be able to route messages that are returned from the Network Prevent for Email Server out to their intended recipients.

Network Prevent for Email Server attempts to initiate a TLS connection with a downstream MTA only when the upstream MTA issues the STARTTLS command. The TLS connection succeeds only if the downstream MTA or hosted email service supports TLS. It must also authenticate itself to the Network Prevent for Email Server. Successful authentication requires that the appropriate keys and X509 certificates are available for each mail server in the proxied message chain.

See the *Symantec Data Loss Prevention MTA Integration Guide for Network Prevent for Email* for information about configuring TLS support for Network Prevent for Email servers operating in forwarding mode or reflecting mode.

[About TLS authentication](#)

## About selecting an integration architecture

You can choose from several suggested integration architectures for the Network Prevent for Email Server.

[About integration architectures](#)

The architecture you implement depends on your existing messaging architecture, the capabilities of your MTA, and your organization's messaging needs. Work closely with your messaging team to identify the best solution for your environment. You may decide that the best solution for your environment requires an integration architecture other than one of those that Symantec suggests.

---

# Network Prevent for Email Server Response Rules

---

## About Network Prevent for Email response rules

This chapter describes the behavior and functionality of Network Prevent for Email Server. It discusses blocking and redirecting messages, as well as tagging message headers.

Network Prevent for Email Server monitors and analyzes outbound email traffic in-line and (optionally) blocks, redirects, or modifies email messages as specified in your policies. You create policies for the Network Prevent for Email Server in the Enforce Server administration console. Policy authors can configure a policy for prevention (in-line management) or for monitoring only on a per-policy basis.

See the [Symantec Data Loss Prevention Help](#) for details on creating response rules and policies.

## About message blocking

You can configure Network Prevent for Email Server to block delivery of those messages that violate a policy. Network Prevent for Email Server blocks messages by returning an SMTP 5xx failure response code.

You can also specify that a customized non-delivery report be sent back to the message sender when a message is blocked. To use a non-delivery report, create a Block SMTP Message response rule in the Enforce Server administration console. The non-delivery report (or bounced message) contains whatever text you specify in the response rule. The MTA generates the report at the moment the message is blocked.

MTA-generated non-delivery reports are different from sender notifications, which can be configured as another type of response rule. The Enforce Server generates sender notifications. When connectivity between the Network Prevent for Email Server and the Enforce Server is normal, only a few seconds should elapse before the sender notification message is generated. However, if connectivity is interrupted between the Network Prevent for Email Server and Enforce Server, the sender notification message is not generated until connectivity is restored.

You can configure email message blocking and Enforce server-generated sender notification actions in the Enforce Server administration console on the **Add/Edit Response Rule** screen. Then you can include response rules in the appropriate policies.

See the [Symantec Data Loss Prevention Help](#) for details on creating response rules and policies.

## About messages redirecting

You can redirect messages violating a policy to an address that is configured in a Block SMTP Message response rule. This address is typically a mailbox or list used by administrators or managers to review and release the messages. These mailboxes are outside of the Symantec Data Loss Prevention system. For this feature to work correctly, you must configure all such redirect addresses as individual sender exceptions on each Prevent-integrated MTA or hosted email service.

Keep redirect addresses in policies synchronized with sender exception addresses configured on the Prevent-integrated MTAs or hosted email service.

To enable and configure message redirection in a Block SMTP Message response rule, enter an address in the **Redirect Message to this Address** field of the Enforce Server administration console's **Add/Edit Response Rule** page.

---

## About downstream message tagging

Gateway-based message encryption systems can be configured to take specified actions based on keywords in the message subject. Certain RFC-5322 message headers can be used for the same purpose. The typical practice is to specify actions based on extension headers that start with "X-".

**You can configure a policy to modify a message in one or all of the following ways:**

- Replace, append, or change the beginning of the subject line.
- Generate a new header that can trigger further processing in the Prevent-integrated MTA or hosted email service. The processing may include message encryption, message quarantine, message archiving, or some other action.

If your MTA or hosted email service is capable of interpreting headers to process message routing rules, you can configure further actions to perform when violations are detected. Create a Modify SMTP Message response rule on the Enforce Server **Add/Edit Response Rule** screen. You can add up to three RFC 5322 header lines. Symantec recommends using the `-Cfilter` header with different values depending upon the scan verdict. You may also change or replace the Subject header.

**Table 1: Examples of Network Prevent for Email Server-added headers**

Example Header	Description
X-CFilter: Encrypt	Requests end-to-end encryption for the message.
X-CFilter: Quarantine	Requests quarantining for the message.
X-CFilter: Archive	Requests archiving for the message.

Be sure to keep the configuration of your message encryption system synchronized with the relevant details of Symantec Data Loss Prevention policies.

You can enable and configure message tagging for downstream encryption by creating Modify SMTP Message response rules on the **Add/Edit Response Rule** screen. Then you can use the rules to set up an appropriate incident remediation workflow on a per-policy basis.

---

# MTA Integration Architecture

---

## About integration architectures

This chapter explains how the Network Prevent for Email Server integrates into the message chain, and it describes several architectures for achieving this integration.

**You can configure the Network Prevent for Email Server to operate in either of the following modes:**

- **Reflecting mode**  
In reflecting mode, the Network Prevent for Email Server acts as an RFC-5321-compliant SMTP proxy. It receives messages from an MTA, analyzes them, and then sends them back to the same MTA. The Network Prevent for Email Server blocks or modifies messages when your policies require it.
- **Forwarding Mode**  
In forwarding mode, the Network Prevent for Email Server acts as an RFC-5321-compliant SMTP proxy that receives messages from an upstream MTA. It analyzes messages and then sends them on to a downstream MTA or to a hosted email service such as Email Security.cloud (instead of reflecting them back to the original MTA). Because the server supports SMTP error response relay and the DNS SMTP extension, it can relay message status as a proxy between two MTAs.  
You can configure the Network Prevent for Email Server to proxy messages to specific IP addresses or host names you specify in your server configuration. Or, you can configure Network Prevent for Email Server to perform MX record lookups for the host names you specify in the configuration. By performing MX record lookups, Network Prevent for Email Server can use DNS load balancing and failover capabilities when it selects the next hop MTA or hosted mail server.

## About the Network Prevent for Email Server message chain

The Network Prevent for Email Server works by integrating into your organization's message chain.

**Figure 1: Network Prevent for Email Server operating in reflecting mode**

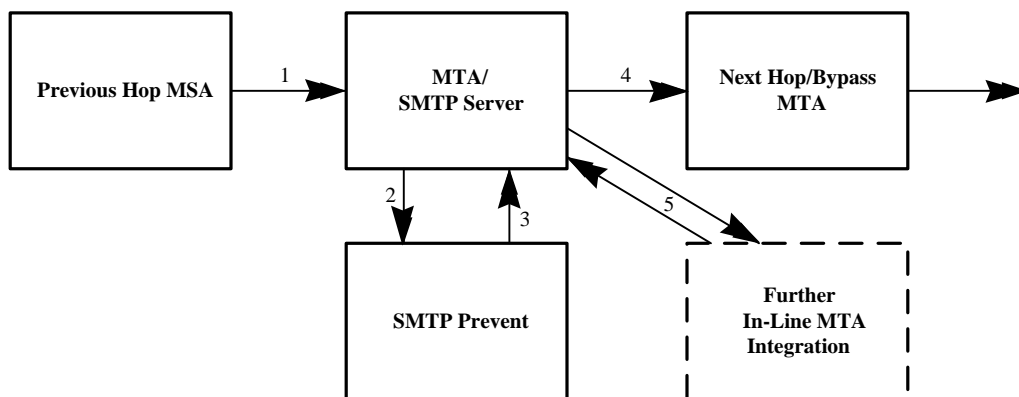



**Figure 2: Network Prevent for Email Server operating in forwarding mode**

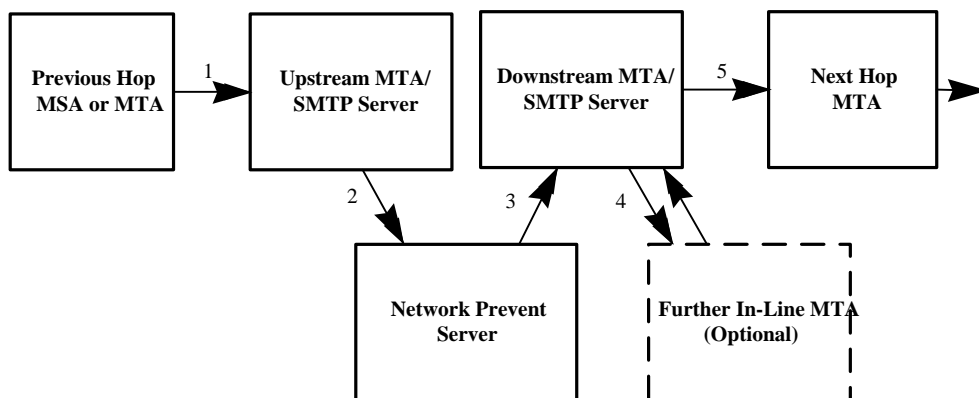

The following list describes the message chain for the Network Prevent for Email Server operating in reflecting mode and the Network Prevent for Email Server operating in forwarding mode:

- A message submission agent (MSA) or an MTA sends an SMTP message to the Prevent-integrated MTA or the upstream MTA.
- Depending on your setup, one of the following occurs. The Prevent-integrated MTA determines that the message has not come from the Network Prevent for Email Server, and the MTA routes it to that server. Or, the upstream MTA routes the message to the Network Prevent for Email Server.  
When the Network Prevent for Email Server receives the SMTP message, it analyzes the message against your Symantec Data Loss Prevention policies.  
The Network Prevent for Email Server does not end the SMTP session until it forwards the message and ends the forwarding session.
- The Network Prevent for Email Server handles the message in one of several ways, based on your policies and response rules as shown in [Message handling](#).
- Optionally, the Prevent-integrated MTA, or a downstream MTA, can send the SMTP message to other in-line MTAs for further processing (such as encryption). The SMTP message returns to the MTA.  
For the Network Prevent for Email Server to trigger message encryption, the Prevent-integrated MTA or the downstream MTA must be able to encrypt the message itself or route the message to an in-line MTA that encrypts. The Prevent-integrated MTA or downstream MTA must be able to use header information to determine the appropriate action.
- The Prevent-integrated MTA, or the downstream MTA or hosted email service provider, sends the SMTP message to the next-hop MTA or out to the Internet to a selected mail server.

**Table 2: Message handling how a response is triggered and how the message is handled**

Trigger	Configured Response	Message Handling
Message does not violate a policy	None	Symantec Data Loss Prevention sends the message (unchanged) back to the Prevent-integrated MTA or to the downstream MTA or hosted email service.
Message violates a policy	Block SMTP Message	This rule blocks the message by returning a 550 SMTP message to the Prevent-integrated MTA or to the upstream MTA. You can configure the 550 response text to contain a reason for the failure or a contact address. You can also configure Symantec Data Loss Prevention to replace the envelope recipient.
Message violates a policy	Modify SMTP Message	This rule lets you automatically modify or replace the message subject line and add as many as three SMTP headers to the message. Modified subject lines and extra SMTP headers can trigger downstream processing. Modified message subject lines can also make a message more user-friendly.

Trigger	Configured Response	Message Handling
Message violates a policy	Send Email Notification	This rule lets you automatically send an incident email notification to a list of recipients and the original sender of the message.

## Integration architectures for reflecting mode

Four integration architecture options are compatible with the Network Prevent for Email Server operating in reflecting mode:

- Second SMTP Listener-Based Routing
- SMTP Client IP Address-Based Routing
- HELO Identification String-Based Routing
- Message Header-Based Routing

The options are listed in order from most secure to least secure. You should choose the first integration architecture on the list that matches the capabilities of your MTA. If none of these integration architectures fit your message stream, you may have other options. Contact your messaging group and your MTA vendor to discuss alternative possibilities for integration.

### NOTE

Symantec recommends you configure outbound messages automatically generated by the Prevent-integrated MTA to bypass the Network Prevent for Email Server.

The following sections describe each of the integration options in detail.

## About second SMTP listener-based routing

To implement Second SMTP Listener-Based Routing, you configure the Prevent-integrated MTA to determine how to process and route an SMTP message based on which of two TCP ports received the message.

You configure one SMTP listener (TCP port 25) to route SMTP messages that are received from the Prevent-integrated MTA to the Network Prevent for Email Server—unless the message meets some criteria that requires it to bypass the Network Prevent for Email Server. You configure the second SMTP listener (TCP port 10026) to listen for SMTP sessions only from Network Prevent for Email Servers. Messages that are received on the SMTP Prevent listener are forwarded further on the message chain. The Second SMTP Listener-based routing is the most secure integration architecture.

**Figure 3: Second SMTP listener port-based routing**

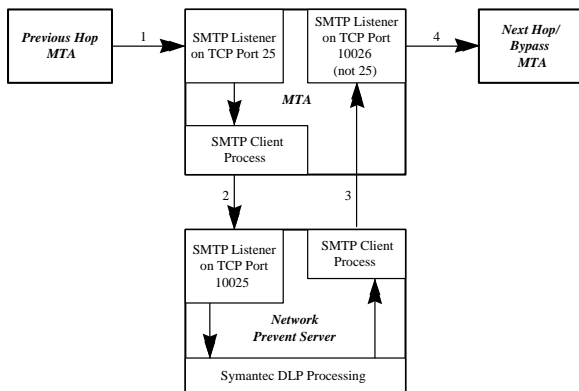

Details about SMTP listener port-based routing are as follows:

- The Prevent-integrated MTA SMTP listener receives a message on port 25.
- The Prevent-integrated MTA SMTP sender routes the message for inspection to the Network Prevent for Email Server SMTP listener on TCP port 10025. (TCP port 10025 is the default port number. You can change this number.)
- The Network Prevent for Email Server inspects the message and, if the server does not block the message (based on the relevant policy), it reflects the message back to the Prevent-integrated MTA on TCP port 10026. (The message is reflected back to TCP port 10026 by default, but you can set any port other than 25 to receive the message.)
- The Prevent-integrated MTA SMTP listener receives the message on port 10026. It determines that the message comes from a valid Network Prevent for Email Server because of the TCP port number. Your message stream architecture and any headers the Network Prevent for Email Server modifies determine the next hop in the message delivery.

## About SMTP client IP address-based routing

To implement SMTP Client IP Address-Based Routing, you configure the Prevent-integrated MTA to determine how to process and route an SMTP message based on the IP address of the previous hop.

SMTP Client IP Address-based routing is secure as long as the IP address is obtained from a reliable source. The most reliable source of the true IP address is directly from the TCP connection information. It is not reliable to extract the IP address from header information, which can be forged. If you use an alternative method (for example, reading the received header that the SMTP Listener placed into the message), then the SMTP Client IP Address-based routing integration architecture is only as secure as the SMTP Listener's ability to ascertain the IP address.

**Figure 4: SMTP client IP address-based routing**

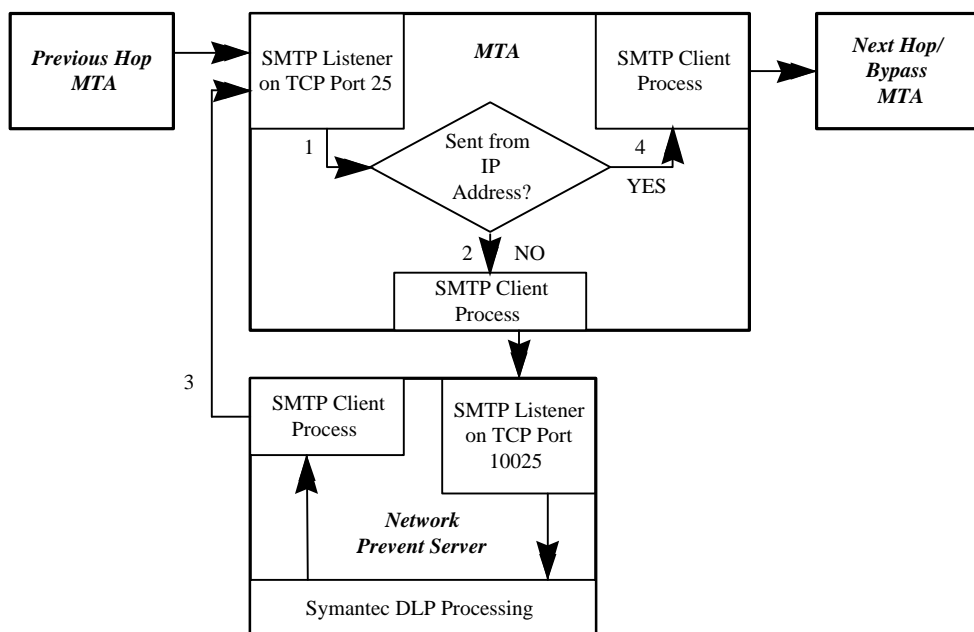

**Details about SMTP client IP-based routing are as follows:**

- The Prevent-integrated MTA SMTP listener receives a message on port 25.
- The Prevent-integrated MTA examines the message to determine the sender IP address. If the sender IP address does not match an IP on the Prevent-integrated MTA delivery list of Network Prevent for Email Server IP addresses,

then the Prevent-integrated MTA routes the message for inspection to the Network Prevent for Email Server SMTP listener on TCP port 10025. (TCP port 10025 is the default port number. You can change this number.)

- The Network Prevent for Email Server inspects the message and, if the server does not block the message (based on the relevant policy), then the message is reflected back to the Prevent-integrated MTA on TCP port 25.
- The Prevent-integrated MTA determines, based on the IP address, whether or not the message comes from a valid Network Prevent for Email Server. It matches the Network Prevent for Email Server SMTP client IP address against the Prevent-integrated MTA list of SMTP client IP addresses. If the sender IP address matches an IP on the Prevent-integrated MTA list of Network Prevent for Email Server IP addresses, then the Prevent-integrated MTA processes the message based upon the appropriate next hop. Your message stream architecture and any headers the Network Prevent for Email Server modifies determine the next hop in the message delivery.

## About HELO identification string-based routing

To implement the HELO Identification string-based routing integration architecture, you configure the Prevent-integrated MTA to determine how to process SMTP messages based on the HELO identification string.

Determining the next hop based on the HELO identification string is a relatively secure way to integrate the Network Prevent for Email Server into your message stream. The HELO response of an email client is difficult to alter; however, forcing the use of an IP address is more secure.

**Figure 5: HELO identification string-based routing**

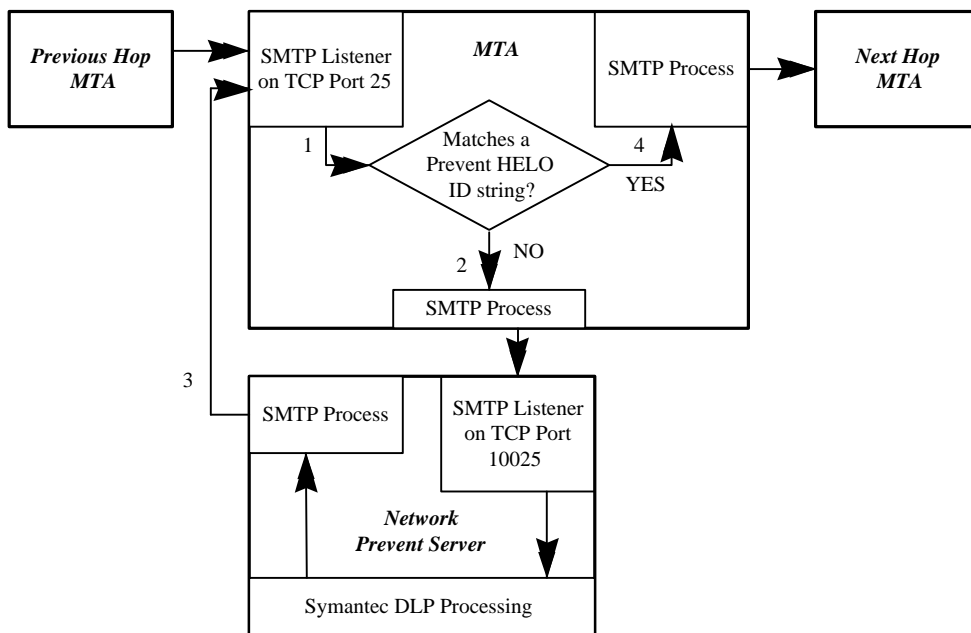

**Details about HELO identification string-based routing are as follows:**

- The Prevent-integrated MTA SMTP listener receives a message on port 25, and the Prevent-integrated MTA captures the HELO ID string.
- The Prevent-integrated MTA examines the message to determine the sender's HELO ID string. If the sender HELO ID string does not match a HELO ID string on the Prevent-integrated MTA list of Network Prevent for Email Server HELO ID strings, then the Prevent-integrated MTA routes the message for inspection to the Network Prevent for Email Server SMTP listener on TCP port 10025. (TCP port 10025 is the default port number. You can change this number.)
- The Network Prevent for Email Server inspects the message and, if the server does not block the message (based on the relevant policy), it reflects the message back to the Prevent-integrated MTA on TCP port 25.
- The Prevent-integrated MTA examines the message to determine the sender's HELO ID string. If the sender HELO ID string matches a HELO ID string on the Prevent-integrated MTA list of Network Prevent for Email Server HELO ID

strings, then the Prevent-integrated MTA processes the message based upon the appropriate next hop. Your message stream architecture and any headers the Network Prevent for Email Server modifies determine the next hop in the message delivery.

## About message header-based routing

To implement the Message Header-Based Routing integration architecture, you configure the Prevent-integrated MTA to determine how to process SMTP messages based on the existence of an informational message header.

If your MTA uses message headers to determine the next hop for a message, a user can easily circumvent detection using common Mail User Agents (MUA). Symantec recommends choosing another integration method if any is available; however, this method does provide a fully functional integration.

**Figure 6: Message header-based routing**

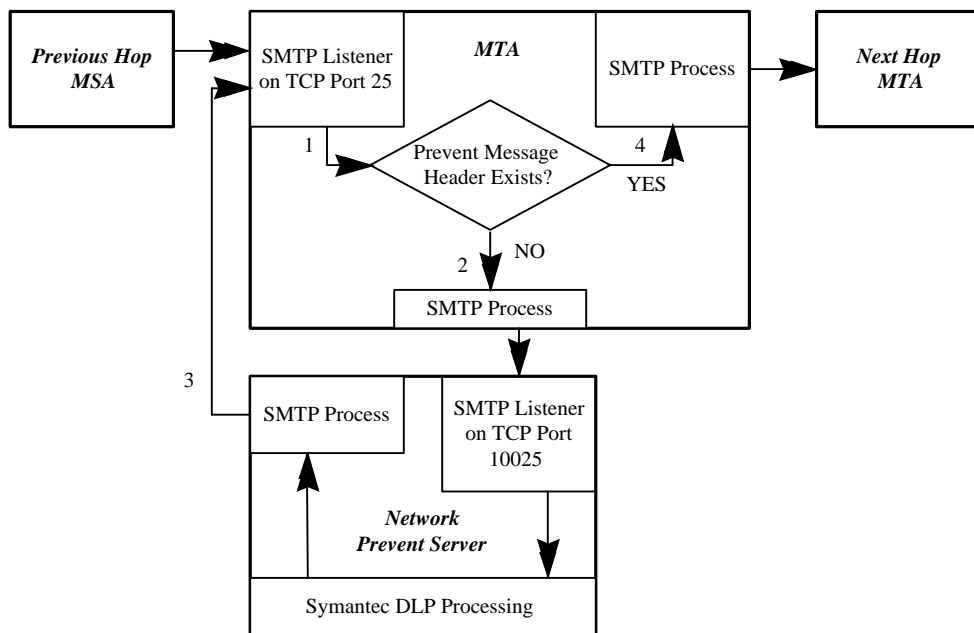

### Details about message header-based routing are as follows:

- The Prevent-integrated MTA SMTP listener receives a message on port 25.
- The Prevent-integrated MTA examines the message's headers. If the MTA finds no header inserted by the Network Prevent for Email Server, then the MTA routes the message for inspection to the Network Prevent for Email Server SMTP listener on TCP port 10025. (TCP port 10025 is the default port number. You can change this number.)
- The Network Prevent for Email Server inspects the message and, if the server does not block the message (based on the relevant policy), then it inserts a header and reflects the message back to the Prevent-integrated MTA on TCP port 25.
- The Prevent-integrated MTA examines the message to determine whether the Network Prevent for Email Server header exists. If the header exists, then the Prevent-integrated MTA processes the message based upon the appropriate next hop. If the Network Prevent for Email Server added additional headers to the message, then the Prevent-integrated MTA might make a different routing decision. Your message stream architecture and any headers the Network Prevent for Email Server modifies determine the next hop in the message delivery.

## About the integration architecture for forwarding mode

In forwarding mode, the Network Prevent for Email Server operates as an SMTP proxy between an upstream MTA and a downstream MTA or hosted email service provider. The Network Prevent for Email Server relays responses

from the downstream host back to the upstream MTA. To configure the Network Prevent for Email Server to operate in forwarding mode, you must select the **Forward** option in the Inline SMTP section of the Network Prevent for Email Server configuration page and configure the **Next MTA** field.

### [Configuring Network Prevent for Email Server for reflecting or forwarding mode](#)

**Figure 7: Architecture of Network Prevent for Email Server operating in forwarding mode**

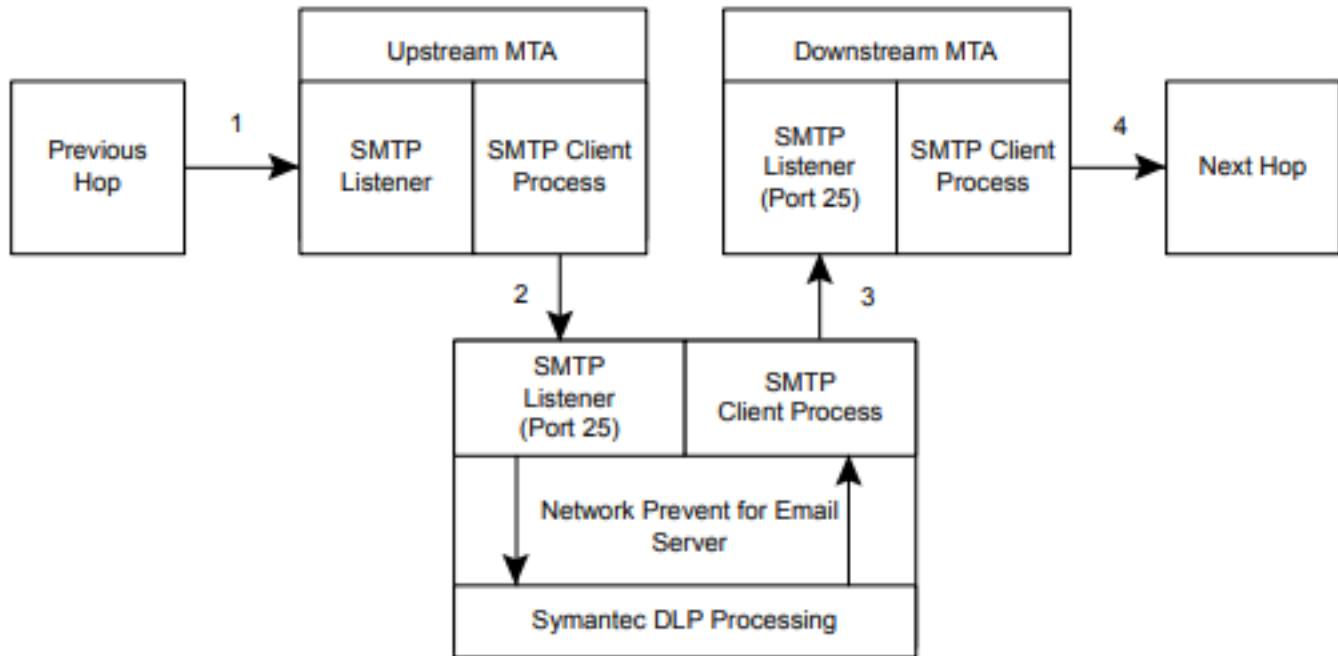

#### **Details about Network Prevent for Email Server operating in forwarding mode are as follows:**

- The upstream MTA SMTP listener receives a message.
- The upstream MTA routes the message to the Network Prevent for Email Server SMTP listener on TCP port 25. (By default, the configured TCP port number is 10025, but Symantec recommends that you change the port to 25.)
- The Network Prevent for Email Server inspects the message. If the server does not block the message (based on a configured policy), it proxies the message to a downstream MTA or hosted mail server. The IP address for this next hop in the message chain can be specified in the Network Prevent for Email Server configuration. It can also be obtained through an MX record lookup of a configured domain name.
- The downstream MTA or hosted mail server sends the SMTP message to the next-hop MTA hosted mail server. A hosted email service may perform additional tasks, such as detecting viruses in the message or encrypting the message contents, before proxying to the receiving MTA.

### **About next-hop MTA selection**

When Network Prevent for Email Server proxies a message after it performs detection, it uses a configured list of mail server addresses to determine the next-hop server. Network Prevent for Email Server can use the mail server addresses (DNS names or IP addresses) as they are configured, or can perform MX-record lookups for a configured domain.

If MX-record lookups are not enabled, Network Prevent for Email Server attempts to forward messages to the first configured mail server address in the list. If it cannot establish a connection to the mail server, it tries the subsequent server addresses in the listed order.

---

If you enable MX-record lookups, Network Prevent for Email Server performs a DNS query to obtain the mail exchange (MX) records for a configured domain. Network Prevent for Email Server uses the returned MX records to select the next-hop mail server in the proxy chain.

An MX record specifies the address of a mail server for a particular domain, as well as an MX preference number. The MX preference assigns priority to multiple MX records that are returned for the same domain. The Network Prevent for Email Server and all SMTP clients observe the following rule associated with the MX preference:

- Mail servers that have lower-numbered MX preferences are used before the servers that have higher MX preferences.

For example, assume that you have configured Network Prevent for Email Server to perform MX lookups, and that you have entered a single address, `emailcompanyname.com`, in the list of next-hop MTAs. Network Prevent for Email Server performs a DNS lookup and receives the following MX records:

```
emailcompanyname.com 10 smtp1.emailcompanyname.com
emailcompanyname.com 10 smtp2.emailcompanyname.com
emailcompanyname.com 10 smtp3.emailcompanyname.com
emailcompanyname.com 40 smtp4.emailcompanyname.com
```

In this case, Network Prevent for Email Server chooses the first of the three servers with MX preference 10 (`smtp1`, `smtp2`, and `smtp3`) as the next hop MTA. The DNS `rrset-order` determines the order of MX records based on the configured load-balancing algorithm, which is generally cyclic (round-robin). The final server, `smtp4`, is chosen only if none of the servers with MX preference 10 are available.

You use the Enforce console to configure the valid list of next-hop mail server addresses.

## About TLS authentication

Network Prevent for Email Server uses TLS with a downstream MTA only when:

- The upstream MTA requests a TLS connection using the `STARTTLS` command, and
- The downstream MTA or hosted email service supports TLS and can authenticate itself.

These conditions also apply when Network Prevent for Email operates in reflecting mode, where a single MTA acts as both the upstream and downstream MTA.

When TLS is requested, each successive proxy in the email chain must authenticate itself to the previous server to establish an end-to-end TLS connection. Successful authentication requires that each mail server stores a valid certificate for the next-hop mail server in its trust store. For example, Network Prevent for Email Server must authenticate itself to the sending MTA, and the downstream MTA or hosted email service must authenticate itself to Network Prevent for Email Server.

### NOTE

Each MTA performs its own authentication setup, and an MTA in the email chain can potentially choose to ignore certificate validation. This practice is not recommended for production email configurations.

If you configure an upstream MTA to bypass Network Prevent for Email Server if the server is unavailable, then the upstream MTA must store a certificate for the downstream mail server as well as the certificate for Network Prevent for Email Server.

## Configuring keys and certificates for TLS

In a typical forwarding-mode MTA integration, the following keys and certificates are required to support TLS:

- The keystore of the upstream MTA must contain the public key certificate for Network Prevent for Email Server. This key is required if the upstream MTA decides to authenticate Network Prevent for Email as part of the TLS session.
- The Network Prevent for Email Server keystore must contain its own private key as well as a public key certificate for the downstream MTA or hosted email server
- If the upstream MTA is configured to bypass Network Prevent for Email Server when the server is unavailable, the upstream MTA trust store must also contain a valid certificate for the downstream MTA or hosted email service.

In a reflecting-mode MTA integration, a single MTA acts as both the upstream MTA and downstream MTA. The reflecting-mode MTA must contain the public key certificate for the Network Prevent for Email Server. The Network Prevent for Email Server keystore must contain its own private key as well as the public key certificate for the integrated reflecting-mode MTA. If the reflecting-mode MTA is configured to bypass Network Prevent for Email Server when the server is unavailable, the MTA trust store must also contain a valid certificate for the downstream MTA or hosted email service.

Hosted mail servers generally use a public key certificate that is digitally signed by a root certificate authority (CA). You must obtain the CA-signed public key certificate from your hosted email service provider and add it to the Network Prevent for Email Server keystore for forwarding-mode configurations. Add the key to the reflecting-mode MTA keystore in reflecting-mode configurations.

Any certificate that you add to the Network Prevent for Email keystore must be an X.509 certificate in Private Enhanced Mail (.pem) Base64-encoded Distinguished Encoding Rules (DER) certificate format, enclosed within -----BEGIN CERTIFICATE----- and -----END CERTIFICATE----- strings in the certificate file.

**Table 3: Configuring keys and certificates for TLS**

Step	Action	Description
Step 1	Change the default keystore password for Network Prevent for Email Server.	Use the Java <code>keytool</code> utility to change the default Network Prevent for Email Server keystore password to a secure password. Then use the Enforce Server administration console to configure Network Prevent for Email Server to use the updated password. <a href="#">Changing the Network Prevent for Email Server keystore password</a>
Step 2	Generate the key pair for Network Prevent for Email Server.	Use the Java <code>keytool</code> utility to generate a public/private key pair for Network Prevent for Email Server. <a href="#">Generating Network Prevent for Email Server keys</a>
Step 3	Export the public key certificate from the Network Prevent for Email Server keystore.	Use the <code>keytool</code> utility to export the self-signed certificate for the public key you generated in Step 2. <a href="#">Exporting the Network Prevent for Email Server public key certificate</a>
Step 4	Import the Network Prevent for Email Server public key certificate into the upstream MTA keystore or reflecting-mode MTA keystore.	Use <code>keytool</code> to import the public key certificate file you exported in Step 3 into the upstream MTA keystore. This enables the MTA to authenticate Network Prevent for Email Server for TLS communication. See your MTA documentation for instructions about how to import public key certificates.



Step	Action	Description
Step 5	Obtain the public key certificate for the next-hop MTA or hosted email service.	Obtain the public key certificate file for any next-hop MTA that you manage in the network. See your MTA documentation for instructions about how to export the certificate. If you are accessing an external, hosted mail server as the next hop in the TLS proxy chain, obtain the public key certificate from your provider. See your email hosting service provider documentation for instructions.
Step 6	For forwarding-mode integrations, add the next-hop public key certificate to the Network Prevent for Email Server keystore.	Use the Java <code>keytool</code> utility to import the downstream MTA's or hosted mail server's public key certificate into the Network Prevent for Email Server keystore. <a href="#">Importing public key certificates to the Network Prevent for Email Server keystore</a>
Step 7	For reflecting-mode integrations, add the next-hop public key certificate to the reflecting-mode MTA keystore.	See your MTA documentation for instructions about how to import public key certificates.

## Changing the Network Prevent for Email Server keystore password

When you install Network Prevent for Email Server, the installer creates an empty keystore file in the install directory:

`C:\ProgramData\Symantec\DataLossPrevention\DetectionServer\15.7\Protect\keystore\prevent.ks`. This keystore file has an initial password: `dummyspassword`. Use the following procedure to change the keystore password.

1. Change to the `C:\Program Files\Symantec\DataLossPrevention\ServerJRE\1.8.0_202\bin` directory on the Network Prevent for Email Server computer on Windows.
2. Execute the `keytool` utility with the `-storepasswd` option to change the default password. The following example is one command; not three separate commands. Line breaks may be included because the command does not fit on one line.

```
keytool -storepasswd -new prevent_keystore_password -keystore
c:\ProgramData\Symantec\DataLossPrevention\DetectionServer\15.7\
Protect\keystore\prevent.ks -storepass dummyspassword
```

Replace `prevent_keystore_password` with a secure password for the keystore. On Linux systems, the default keystore location is

```
/var/Symantec/DataLossPrevention/DetectionServer/15.7/Protect/keystore/prevent.ks
```

### NOTE

The Network Prevent for Email Server keystore password and key password values must match. Use the same `prevent_keystore_password` when you generate the key for Network Prevent for Email Server.

[Generating Network Prevent for Email Server keys](#)

3. Log on to the Enforce Server administration console that manages the Network Prevent for Email Server.
4. Select **System > Servers > Overview** from the main menu bar.
5. Click the name of the Network Prevent for Email Server you want to configure.
6. Click **Configure**.
7. In the **Security Configuration** section, fill in the fields as follows:

Field	Description
<b>Keystore Password</b>	Enter the correct password for the keystore file. Use the <code>new_password</code> you specified in Step 2.
<b>Confirm keystore Password</b>	Re-enter the keystore file password.

8. Click **Save**.

## Generating Network Prevent for Email Server keys

Each mail server that you manage must have a keystore that contains the keys and X.509 certificates required to authenticate TLS communication. Use the following procedure to create a new public and private key pair in the keystore file.

1. Change to the `c:\Program Files\Symantec\DataLossPrevention\ServerJRE\1.8.0_202\bin` directory on the Network Prevent for Email Server computer.
2. Execute the `keytool` utility with the `-genkeypair` and `-keystore` options to add a new public and private key to the keystore:

```
keytool -genkeypair -dname "dname_string" -alias smtp_prevent
-keyalg RSA -keystore keystore c:\ProgramData\Symantec\
  DataLossPrevention\DetectionServer\15.7\Protect\keystore\prevent.ks
-storepass store_password -validity expiration_days
-keyalg key_algorithm
```

[Keytool token reference](#) describes the tokens that are used in the command.

For example, the following command generates a new key pair that expires in 90 days:

```
keytool -genkeypair -dname "CN=John Doe, OU=DLP_Development,
O=Symantec, L=SanFrancisco, S=California, C=USA" -alias smtp_prevent
-keyalg RSA prevent_keystore_password
-keystore c:\ProgramData\Symantec\DataLossPrevention\DetectionServer\
  15.7\Protect\keystore\prevent.ks
-storepass prevent_keystore_password -validity 90
-keyalg RSA
```

3. Export the public key certificate that you created. You must import the certificate to any upstream MTAs that need to authenticate Network Prevent for Email Server in the TLS session.

[Exporting the Network Prevent for Email Server public key certificate](#)

**Table 4: Keytool token reference**

Token	Description
dnname_string	The X.500 distinguished name to bind with the public key. The distinguished name generally contains a series of codes for the common name of the person, the organization and organizational unit, and the location that is associated with the key. For example: <pre>-dnname "CN=John Doe, OU=DLP_Development, O=Symantec, L=SanFrancisco, S=California, C=USA"</pre> See the <code>keytool</code> help or Sun <code>keytool</code> documentation for more information about the format of a distinguished name string.
smtp_prevent	The alias for the new key.
key_password	The password for the new key you created. <b>Note:</b> The <code>key_password</code> and <code>store_password</code> values must be identical for Network Prevent for Email Server. <a href="#">Changing the Network Prevent for Email Server keystore password</a>
store_password	The password to modify the keystore file. <b>Note:</b> The <code>key_password</code> and <code>store_password</code> values must be identical for Network Prevent for Email Server. <a href="#">Changing the Network Prevent for Email Server keystore password</a>
expiration_days	The number of days before the new key pair becomes invalid.
key_algorithm	The algorithm that is used to generate the key pair. Some MTAs may require that you set this algorithm to <code>DSA</code> . Some MTAs, such as Microsoft Exchange, require that you set it to <code>RSA</code> . For more information, see the documentation for your MTA.

## Exporting the Network Prevent for Email Server public key certificate

To authenticate Network Prevent for Email Server, the upstream MTA (or reflecting-mode MTA) must store a public key certificate for Network Prevent for Email Server in its local keystore. The next procedure shows you how to export the public key certificate for Network Prevent for Email Server to a file. You can then import the certificate from the file into the keystore for your upstream MTA.

1. Change to the `c:\Program Files\Symantec\DataLossPrevention\ServerJRE\1.8.0_202\bin` directory on the Network Prevent for Email Server computer.
2. Execute the `keytool` utility with the `-exportcert` option to export the public key certificate to a new file:

```
keytool -exportcert -alias smtp_prevent -file smtp_prevent.cer  
-keystore c:\ProgramData\Symantec\DataLossPrevention\DetectionServer\15.7\  
Protect\keystore\prevent.ks -storepass prevent_key_password
```

In this command, `smtp_prevent.cer` is the file name in which you store the public key certificate and `prevent_key_password` is the password to the keystore and the Network Prevent for Email Server key.

3. Import the public key certificate into the keystore of each upstream MTA that must authenticate Network Prevent for Email Server, or to the reflecting-mode MTA. See your MTA documentation for instructions.

## Importing public key certificates to the Network Prevent for Email Server keystore

Each mail server in the TLS proxy chain must authenticate the next-hop mail server. Authentication requires that you add the next-hop mail server certificate to the upstream mail server trust store. The next procedure shows you how to import a next-hop MTA server or hosted mail server public key certificate into the Network Prevent for Email Server keystore.

---

## NOTE

Any certificate that you add to the Network Prevent for Email keystore must be an X.509 certificate in Private Enhanced Mail (.pem) Base64-encoded Distinguished Encoding Rules (DER) certificate format, enclosed within -----BEGIN CERTIFICATE----- and -----END CERTIFICATE----- strings in the certificate file.

### Importing public key certificates

1. Begin by copying the certificate file you want to import onto the Network Prevent for Email Server computer.  
If you manage the next-hop MTA in your network, refer to the MTA documentation for information about exporting the public key certificate.  
If you use a hosted email service as the next-hop server, consult your service provider for information about obtaining the certificate.
2. Change to the `c:\Program Files\Symantec\DataLossPrevention\ServerJRE\1.8.0.202` directory on the Network Prevent for Email Server computer.
3. Execute the `keytool` utility with the `-importcert` option to import the public key certificate into the Network Prevent for Email Server keystore using the following commands. If a command does not fit on one line, it may be displayed here on two lines, but should be entered as one command at the command line.

```
keytool -importcert -alias new_mta_alias  
-file certificate_file  
  
-keystore c:\ProgramData\Symantec\DataLossPrevention\DetectionServer\15.7\  
Protect\keystore\prevent.ks -storepass prevent_key_password
```

In these commands, `certificate_file` is the full path to the public key certificate file you want to import and `store_password` is the keystore password. `new_mta_alias` is a new alias to assign to the imported certificate.

When you import a public keychain that includes a root CA certificate, include the `-trustcacerts` option to verify the full chain, as in:

```
keytool -importcert -alias prevent_alias -file .\smtp_prevent.cer  
-keystore c:\ProgramData\Symantec\DataLossPrevention\DetectionServer\15.7\  
Protect\keystore\prevent.ks -trustcacerts
```

- Repeat these commands for each MTA or hosted mail server that Network Prevent for Email Server might need to authenticate.

## Configuring Network Prevent for Email Server for reflecting or forwarding mode

Use the following instructions to configure Network Prevent for Email Server to operate either in reflecting or forwarding mode.

- Log on to the Enforce Server administration console for the Symantec Data Loss Prevention system you want to configure.
- Select **System > Servers and Detectors > Overview** to display the list of configured servers.
- Click the name of the Network Prevent for Email Server that you want to configure.
- Click **Configure**.
- Deselect **Trial Mode** to enable blocking of email messages that are found to violate Symantec Data Loss Prevention policies.
- Configure reflecting mode or forwarding mode by modifying the following fields:

Field	Description
<b>Next Hop Configuration</b>	<p>Select <b>Reflect</b> to operate Network Prevent for Email Server in reflecting mode. Select <b>Forward</b> to operate in forwarding mode.</p> <p><b>Note:</b> If you select <b>Forward</b> you must also select <b>Enable MX Lookup</b> or <b>Disable MX Lookup</b> to configure the method used to determine the next-hop MTA.</p>
<b>Enable MX Lookup</b>	<p>This option applies only to forwarding mode configurations. Select <b>Enable MX Lookup</b> to perform a DNS query on a domain name to obtain the mail exchange (MX) records for the server. Network Prevent for Email Server uses the returned MX records to select the address of the next hop mail server.</p> <p>If you select <b>Enable MX Lookup</b>, also add one or more domain names in the <b>Enter Domains</b> text box. For example:</p> <p><code>companyname.com</code></p> <p>Network Prevent for Email Server performs MX record queries for the domain names that you specify.</p> <p><b>Note:</b> You must include at least one valid entry in the <b>Enter Domains</b> text box to successfully configure forwarding mode behavior.</p>

Field	Description
<b>Disable MX Lookup</b>	<p>This field applies only to forwarding mode configurations. Select <b>Disable MX Lookup</b> if you want to specify the exact host name or IP address of one or more next-hop MTAs. Network Prevent for Email Server uses the host names or addresses that you specify and does not perform an MX record lookup.</p> <p>If you select <b>Disable MX Lookup</b>, also add one or more host names or IP addresses for next-hop MTAs in the <b>Enter Hostnames</b> text box. You can specify multiple entries by placing each entry on a separate line. For example:</p> <pre>smtp1.companyname.com smtp2.companyname.com smtp3.companyname.com</pre> <p>Network Prevent for Email Server always tries to proxy to the first MTA that you specify in the list. If that MTA is not available, Network Prevent for Email Server tries the next available entry in the list.</p> <p><b>Note:</b> You must include at least one valid entry in the <b>Enter Hostnames</b> text box to successfully configure forwarding mode behavior.</p>

7. Click **Save**.
8. Click **Server Settings** to verify or configure these advanced settings:

Field	Description
<b>RequestProcessor.ServerSocketPort</b>	<p>Ensure that this value matches the number of the SMTP Listener port to which the upstream MTA sends email messages. The default is 10025.</p> <p><b>Note:</b> Many Linux systems restrict ports below 1024 to root access. Network Prevent for Email cannot bind to these restricted ports. If the computer receives mail for inspection on a restricted port (for example, port 25), reconfigure the computer to route traffic from the restricted port to the non-restricted Network Prevent for Email port (port 10025 by default).</p>
<b>RequestProcessor.MTAResubmitPort</b>	<p>Ensure that this value matches the number of the SMTP Listener port on the upstream MTA to which the Network Prevent for Email Server returns mail. The default is 10026.</p>
<b>RequestProcessor.AddDefaultHeader</b>	<p>By default, Network Prevent for Email Server uses a header to identify all email messages that it has processed. The header and value are specified in the <b>RequestProcessor.DefaultPassHeader</b> field.</p> <p>Change the value of this field to false if you do not want to add a header to each message.</p>
<b>RequestProcessor.AddDefaultPassHeader</b>	<p>This field specifies the header and value that Network Prevent for Email Server adds to each email message that it processes. The default header and value is <code>X-Filter-Loop: Reflected</code>.</p> <p>Change the value of this field if you want to add a different header to each processed message.</p> <p>If you do not want to add a header to each email message, set the <b>AddDefaultPassHeader</b> field to False.</p>

---

## NOTE

Always configure both **RequestProcessor.ServerSocketPort** and **RequestProcessor.MTAResubmitPort**, whether you implement reflecting or forwarding mode. With forwarding mode, **RequestProcessor.ServerSocketPort** specifies the SMTP Listener port on the detection server to which the upstream MTA sends email messages. **RequestProcessor.MTAResubmitPort** is the SMTP Listener port on the downstream MTA to which the detection server sends email messages.

9. Click **Save**.
10. Click **Done**.
11. If your email delivery system uses TLS communication in forwarding mode, each next-hop mail server in the proxy chain must support TLS and must authenticate itself to the previous hop. This means that Network Prevent for Email Server must authenticate itself to the upstream MTA, and the next-hop MTA must authenticate itself to Network Prevent for Email Server. Proper authentication requires that each mail server stores the public key certificate for the next hop mail server in its local keystore file.

## Configuring Linux IP tables to reroute traffic from a restricted port

Many Linux systems restrict ports below 1024 to root access. Network Prevent for Email cannot bind to these restricted ports.

If the computer receives mail for inspection on a restricted port (for example, port 25), use the `iptables` command to route that traffic to a non-restricted port, such as the Network Prevent for Email default port 10025. Then ensure that Network Prevent for Email listens on the non-restricted port to inspect email.

Use the following instructions to configure a Linux system to route from port 25 to port 10025. If you use a different restricted port or Network Prevent for Email port, enter the correct values in the `iptables` commands.

To configure route traffic from port 25 to port 10025

1. Configure Network Prevent for Email to use the default port 10025 if necessary.

[Configuring Network Prevent for Email Server for reflecting or forwarding mode](#)

2. In a terminal window on the Network Prevent for Email computer, enter the following commands to reroute traffic from port 25 to port 10025:

```
iptables -N Vontu-INPUT
iptables -A Vontu-INPUT -s 0/0 -p tcp --dport 25 -j ACCEPT
iptables -I INPUT 1 -s 0/0 -p tcp -j Vontu-INPUT
iptables -t nat -I PREROUTING -p tcp --destination-port 25 -j REDIRECT --to-ports=10025
iptables-save > /etc/sysconfig/iptables
```

## NOTE

If you only want to test local IP routing between the ports with Telnet, use the command: `iptables -t nat -I OUTPUT -o lo -p tcp --destination-port 25 -j REDIRECT --to-ports=10025`

If later you decide to delete the IP tables entry, use the command:

```
iptables -t nat -D OUTPUT -o lo -p tcp --destination-port 25 -j REDIRECT --to-ports=10025
```

---

# Capacity and Fault Tolerance

---

## About capacity and fault tolerance

Your message architecture should be designed to accommodate a maximum message load even if one of your MTAs or Network Prevent for Email Servers is temporarily unavailable. It can be unavailable because of maintenance, for example. This chapter provides tips and suggestions for integrating one or more servers into your message architecture while you manage capacity and maintain fault tolerance. You can tailor the exact capacity and fault tolerance specifications to your own requirements. In this chapter, the term message handler refers to any MTA, Network Prevent for Email Server, or other in-line SMTP processor in your message architecture.

## About capacity management and fault tolerance implementation

This section introduces common methods for managing capacity and implementing fault tolerance. Subsequent sections provide more details as well as example implementations of these methods in your message architecture.

A common way to add capacity and fault tolerance to your architecture is to create or expand clusters. Clusters are sets of load sharing systems that perform the same step in your message architecture. You can cluster multiple MTAs and multiple Network Prevent for Email Servers. You can increase the number of Network Prevent for Email Servers independently of the number of MTAs.

**Some ways to add capacity and fault tolerance to your architecture are as follows:**

- MX-based clusters are useful for managing capacity and implementing fault tolerance. You can use mail exchange records (MX records) to distribute email services over a cluster of message handlers. This method of clustering works both for MTAs and Network Prevent for Email Servers. To create this kind of cluster, each message handler must have SMTP listeners on the same TCP ports. Each message handler must also process inbound messages in exactly the same way. The MX record for each message handler in the cluster must have equal MX preference values.  
[About the DNS system](#)
- IP load balancer-based clusters are useful for managing capacity. IP load balancers devices provide a virtual IP address that distributes traffic among several back-end servers over an internal IP network.
- MTA-based queue management is useful for implementing fault tolerance. One or more MTAs in a cluster may be able to check the age of messages queued for a Network Prevent for Email Server. If any messages have been in the queue longer than the configured limit, such MTAs move them to a queue for a different message handler.

## About capacity management

Determine how many MTAs and Network Prevent for Email Servers are needed to ensure that your message architecture can accommodate a peak message load. A conservative estimate of the amount of traffic a Network Prevent for Email Server can handle is approximately 20 messages per second or up to 30 megabits per second of throughput. Differences in the characteristics of the message stream affect the performance of an individual Network Prevent for Email Server. These differences can be the distribution of message sizes and message content types. As you become more familiar with the characteristics of your traffic, you can adjust capacity plans appropriately.

When Network Prevent for Email Servers operate in reflecting mode, Prevent-integrated MTAs handle each outbound message twice, which adds to their processing and CPU load.

[Integration architectures for reflecting mode](#)

## About MX-Based clusters

To use an MX-based cluster to inspect your outbound mail, you can define an equivalent MX preference for each Network Prevent for Email Server in the cluster. If load balancing is required, each record should have the same priority value and



---

point to the fully-qualified domain name (FQDN) of one of the Network Prevent for Email Servers. Any MTA that sends a message to the Network Prevent for Email Servers goes to one of the servers in the cluster.

If the Network Prevent for Email Servers operate in reflecting mode, they reflect messages back to the IP address of the MTA from which the messages arrived. If the Network Prevent for Email Servers operate in forwarding mode, they forward messages to the host or IP addresses that you configure. MX record lookups can also be performed for valid DNS names configured in the next-hop MTA list.

[About next-hop MTA selection](#)

## About IP load balancer-based clusters

When you use an IP load balancer to implement clusters of MTAs and Network Prevent for Email Servers, make sure that every Network Prevent for Email Server can connect back to the MTA cluster. The particular architecture you implement depends on the capabilities of your load balancer and the available routes in your network.

If the load balancer is bi-directional, you can operate the Network Prevent for Email Servers in either reflecting mode or forwarding mode. If the load balancer is uni-directional, you must operate the servers in reflecting mode.

[Example of bi-directional load balancing](#)

[Example of uni-directional load balancing](#)

## Example of bi-directional load balancing

[Load balancing with Network Prevent for Email Servers in forwarding mode](#) shows an architecture that includes a bi-directional load balancer and a cluster of Network Prevent for Email Servers operating in forwarding mode. After receiving and analyzing messages, the Network Prevent for Email Servers forward them to a virtual IP address (VIP) specified in the advanced settings of each Network Prevent for Email Server (in the RequestProcessor.NextMTA field).

For details on configuring forwarding mode and on configuring the Network Prevent for Email Server in general, see the [Symantec Data Loss Prevention Help](#).

[Example of uni-directional load balancing](#)

**Figure 8: Load balancing with Network Prevent for Email Servers in forwarding mode**

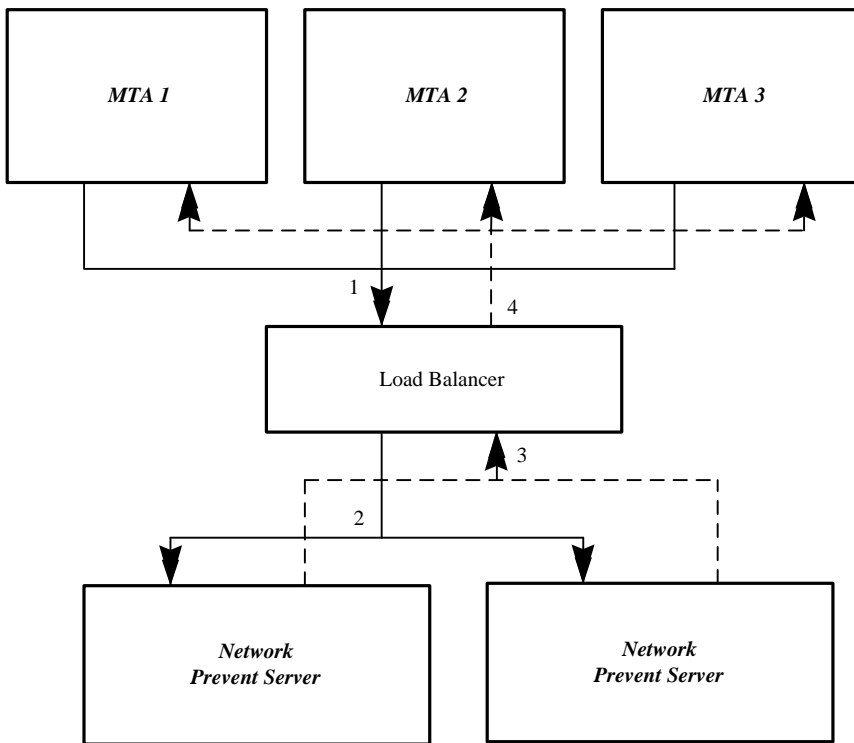

Details about load balancing with Network Prevent for Email Servers in forwarding mode are as follows:

- An upstream MTA creates an SMTP connection to the Network Prevent for Email Server VIP.
- The load balancer rewrites the destination address of each packet in each SMTP session as the IP address of one of the Network Prevent for Email Servers.
- The Network Prevent for Email Server creates a connection to the MTA VIP (specified in the **RequestProcessor.NextMTA** field in the advanced settings of the Network Prevent for Email Server).
- The load balancer rewrites the destination address of each packet in the SMTP session as the IP address of one of the MTAs in the cluster.

Note that you can also operate the Network Prevent for Email Servers in reflecting mode with a bi-directional load balancer. One way to do this is to configure the load balancer to rewrite the source IP address to point to the second (return) VIP on the load balancer. The Network Prevent for Email Servers would then reflect messages back to the return VIP.

### Example of uni-directional load balancing

[Load balancing with Network Prevent for Email Servers in reflecting mode](#) shows an architecture that includes uni-directional load balancing and a cluster of Network Prevent for Email Servers operating in reflecting mode. The servers reflect messages back to the source address, which has not been virtualized by the load balancer.

**Figure 9: Load balancing with Network Prevent for Email Servers in reflecting mode**

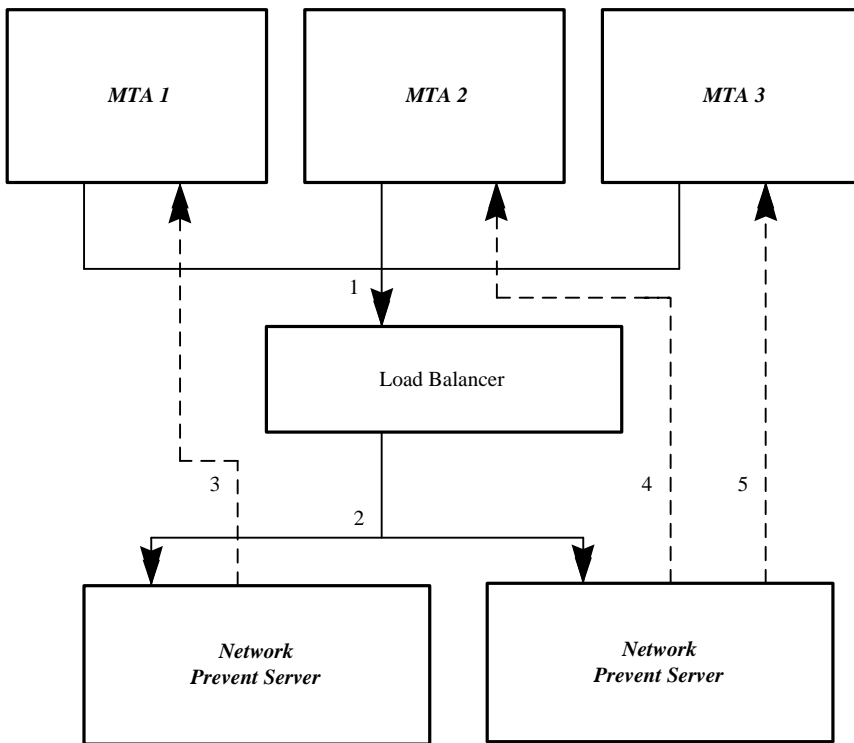

Details about load balancing with Network Prevent for Email Servers in reflecting mode are as follows:

- An MTA creates an SMTP connection to the Network Prevent for Email Server VIP.
- The load balancer rewrites the destination address of each packet in each SMTP session as the IP address of one of the Network Prevent for Email Servers. The load balancer does not rewrite the source address.
- The Network Prevent for Email Server creates a connection directly to the originating MTA based on the unaltered source address of the incoming packet. The same holds for 4 and 5 in the diagram.

## About fault tolerance planning

You should plan how to handle the message stream in the event that an MTA or a Network Prevent for Email Server is not available. If you want to bypass an unavailable Network Prevent for Email Server you can use MX records to define a second cluster for handling mail. Alternately, you can use MTA queue management to move waiting messages to another outbound queue.

[About MX-based bypass](#)

[About MTA-based queue management](#)

As an alternative to these methods, you may want to prevent email messages from exiting your network until a Network Prevent for Email Server is available to analyze them. If you plan to hold messages until a Network Prevent for Email Server becomes available, you do not need to implement either MX-based bypass or MTA queue management. However, you should make sure that clusters include enough capacity to handle any service disruptions.

## About MX-based bypass

If a Network Prevent for Email Server cluster is completely unavailable, you can use MX records to define a second cluster for mail handling. You must define the MX records for the second cluster with a higher precedence (lower priority) than the main Network Prevent for Email Server cluster. Each member of the bypass cluster must have

---

an SMTP listener on the same port on which the Network Prevent for Email Server listens. This is defined in the RequestProcessor.ServerSocketPort field in the advanced settings of the server. A common configuration creates an alternative SMTP listener on a virtual interface of the sending MTA.

The advantages of this method are:

- It works with appliances.
- It is standards-based.

The disadvantage is that email is not forwarded when a Network Prevent for Email Server is still running but is overloaded.

[About fault tolerance planning](#)

[About MTA-based queue management](#)

## **About MTA-based queue management**

If your MTAs let you manipulate their message queues, you can write a program that examines messages bound for the Network Prevent for Email Server. It also should move old messages (as defined by the configured limit) to an outbound queue.

The advantage of this method is that it works for both system failure and system overload. The disadvantage is that you must write custom code to deal with your MTA mail queues, which may not be possible with some appliances.

[About fault tolerance planning](#)

[About MX-based bypass](#)

---

# Integration Testing

---

## About Network Prevent for Email Server integration testing

This chapter outlines the various functional and failover tests that you need to perform to ensure that you have successfully integrated with the Network Prevent for Email Server.

These tests assume an email generator, one or more Prevent-integrated MTAs, two Network Prevent for Email Servers with MX-record failover and load balancing, and a downstream MTA/destination mail host. (These tests involve Symantec Data Loss Prevention policies and response rules.)

For details on response rules and policies, see the [Symantec Data Loss Prevention Help](#).

## About functional tests

MTA functional tests describes common functional you can perform.

**Table 5: MTA functional tests**

Functional Test	Description
No Policy Violated	Confirm that the message stream functions, and that test email messages are handled once and only once by a Network Prevent for Email Server.
Block SMTP Message	Create a response rule that redirects a message to a different address by changing the address. Confirm that the alternative address receives the message. Create a response rule that returns a non-delivery message to the sender. Confirm that the sender received the bounced message and that it contains the configured text from the Symantec Data Loss Prevention policy.
Send Email Notification	Create a response rule that causes an incident message to be sent to a list of addresses (including the sender).
Modify SMTP Message	Create a Modify SMTP Message rule. Then confirm the Network Prevent for Email Server can modify the subject header and that it can add additional headers to the message. If you want the Prevent-integrated MTA or the downstream MTA to act on the responses, confirm that it has taken the appropriate action in response to the modified header. For instance, in response to an X-Filter: Encrypt header, confirm the MTA routed the message to your in-line SMTP encryption server.

## About basic failover tests

You can perform any of the following basic failover tests:

- Disconnect any subset or the entire set of Network Prevent for Email Servers from the message stream. Then confirm that the message stream continues to operate.
- Disconnect any subset or the entire set of Network Prevent for Email Servers from the message stream. Then confirm that the message stream continues to operate. Reconnect the Network Prevent for Email Server, and ensure the email message stream resumes through the Network Prevent for Email Server. Repeat this test multiple times.



---

# Email Message Systems

---

## About store and forward email systems

Email systems are different from other types of network communications. While other communications systems are often end-to-end applications, email message systems are always store-and-forward systems. Email is never delivered directly from a sender application to an email reader application. The sender application sends the mail through a series of Message Transmission Agents (MTAs) that read the message, store it, and then forward it when the next hop is available. The last hop is a message store that holds the message until the email reader client views or downloads the mail. No MTA removes a message from its message queue until it has been successfully delivered to the next hop. The message queue on an MTA is capable of storing a message for anywhere from a few hours to a few days before sending a non-delivery message back to the sender. The final message store is often capable of storing the message indefinitely.

The Network Prevent for Email Server is different from an MTA because it does not store any messages. The Network Prevent for Email Server does not end the SMTP session through which it receives a message until it forwards the message and ends the forwarding session.

[About the Network Prevent for Email Server message chain](#)

## About the DNS system

Information stored in the global DNS systems determines the route the email takes from sender to recipient. The DNS system is a hierarchical system that manages the mapping between named elements on the Internet and the underlying systems supporting those names. For instance, an address record (A record) relates a host's fully-qualified domain name (FQDN) to its IP address or the address that routers can use to send a packet to that host. The reverse of that mapping is stored in a pointer record (PTR record). A mail exchange record (MX record) is a special record that is used only by mail systems. An MX record identifies a mail domain name (the part of an email address that comes after the @) to a system that provides mail service for that mail domain.

All hosts that run SMTP-compliant MTAs are required to have valid A and PTR records. SMTP-compliant MTAs might not function correctly if, for example, a PTR record does not exist for that host or the PTR record for that host is not synchronized with the A record. An MX record relates the email domain to a valid A record for a host that knows how to deliver email for that domain. It also associates a delivery priority value for that particular host when it sends mail to that mail domain.

When the DNS system is queried for the MX records that match a given email domain, it returns a list of all of the matching MX records with both the address values and their priorities. An SMTP-compliant MTA that receives more than one matching record first attempts to make a connection to the lowest precedence value (or highest priority) server for that mail domain. If that connection fails, a connection to the next-highest priority server for that domain is attempted. This process continues until either a connection is made or all of the hosts on the list are exhausted. When all of the hosts on the list are exhausted, the message is stored for a while, and another attempt to deliver the message is made. An elementary form of load sharing can be implemented by having multiple MX records listed with the same priority. Priority values can have any value that is represented by a 16-bit integer, but most often the values used are powers of 5.

[About MX-based bypass](#)

---

# MTA Integration Checklist

---

## About the MTA integration checklist

This appendix provides general guidance, in the form of a checklist, on how to integrate Network Prevent for Email Server into your SMTP messaging architecture.

## Completing the Network Prevent for Email Server integration prerequisites

This section outlines tasks to complete before you decide which MTA integration architecture to implement. Research your company's existing SMTP-message routing architecture and MTA implementations by performing the following tasks.

1. Identify the key personnel in charge of the creating DNS entries, managing the network for the servers on the message chain, and information security.
2. Gather computer and function maps for all message processing servers, including the MTA to be integrated.
3. For each MTA host to be integrated, gather the IP address, subnet mask, default gateway IP address, host name (short), fully-qualified domain name, and the DNS server IP addresses for each NIC.
4. For each MTA host to be integrated, obtain the administrator account with user name and password.
5. If you use TLS for communication between MTAs, obtain the location and password of each MTA keystore. In addition, you must obtain the public certificate for each MTA that must authenticate itself during TLS communication. Network Prevent for Email Server requires an X.509 certificate in .pem format.

### [About TLS authentication](#)

6. Read the section on MTA compatibility and requirements, and confirm that your existing MTA meets these requirements.

### [Environment compatibility and requirements for Network Prevent for Email](#)

If your existing MTA does not meet the requirements or cannot perform the suggested integration architectures, consider using an MTA that does meet the requirements.

7. Read the section about the Network Prevent for Email Server in the message chain to understand how the server fits into the message chain.

### [About the Network Prevent for Email Server message chain](#)

8. Review the sample integration architectures.

### [Integration architectures for reflecting mode](#)

### [About the integration architecture for forwarding mode](#)



---

## Selecting an integration architecture

This section describes how to select an integration architecture that best suits your messaging environment.

1. Select one of the following Network Prevent for Email Server failure modes: Block on Prevent failure or Pass through on Prevent failure.
2. If you chose the Pass through on Prevent failure mode, select a failover implementation: MX-record-based pass through on Prevent failure or MTA code-based pass through on Prevent failure.
3. Choose an MTA integration architecture.

[Integration architectures for reflecting mode](#)

[About the integration architecture for forwarding mode](#)

[About fault tolerance planning](#)

## Evaluating message stream component capacity

This section outlines the tasks you need to accomplish to determine your messaging environment's message stream component capacity.

1. Determine number of MTAs to be integrated.
2. Determine the number of Network Prevent for Email Servers.
3. Determine number of MX-record-based pass-through MTAs (real or virtual).

[About integration architectures](#)

[About fault tolerance planning](#)

## Integrating Network Prevent for Email with MTAs

This section provides a high-level overview of major steps in implementing Network Prevent for Email.

[About integration architectures](#)

1. Install and configure your MTA software depending on your chosen integration architecture.

If you are running the Network Prevent for Email Server in reflecting mode, configure each Prevent-integrated MTA to receive reflected messages on the port you specified in the RequestProcessor.MTAResubmitPort advanced setting of the Network Prevent for Email Server. Configure each MTA to send any mail not already inspected by a Network Prevent Server to the Network Prevent Server cluster, unless the cluster is unavailable and you want to forward mail to a bypass MTA.

If you are running the Network Prevent for Email Server in forwarding mode, configure each upstream MTA to forward all mail to the Network Prevent Server cluster, unless the cluster is unavailable and you want to forward mail to a downstream MTA. Then configure each downstream MTA to forward all mail received from any upstream MTA or Network Prevent Server to the appropriate next hop. If you use a hosted email service provider instead of a next-hop MTA, configure it to perform any additional processing of messages before it delivers mail. If the hosted email service uses TLS communication, obtain the root CA-signed public key certificate for the email service.

[About downstream message tagging](#)

[About TLS authentication](#)

Contact your MTA vendor for support, if required.

- 
2. Install and configure your Network Prevent for Email Servers.

See the [Symantec Data Loss Prevention Help](#) for installation and configuration information.

3. Create the appropriate DNS records for all message handlers (MTAs, Network Prevent Servers, and other in-line SMTP processors), including the following:
  - A (address) records (for all MTA interfaces, real and virtual) associated with any MX records required to implement your MTA and Network Prevent Server clusters.
  - PTR records (for all interfaces, real and virtual) associated with any MX records required to implement your MTA and Network Prevent Server clusters.
  - Load balancing MX records for the MTAs to be integrated.
  - Load balancing MX records for your Network Prevent Server cluster and for the bypass MTA cluster, if any.

[About the DNS system](#)

4. Test your integration before deploying to your production environment.

[About Network Prevent for Email Server integration testing](#)

